

UNCONTROLLED DOCUMENT

PART NUMBER		REV.
SML-LX2723UPGC-TR		A
REV.	E.C.N. NUMBER AND REVISION COMMENTS	DATE
A	E.C.N. #11459.	12.07.07

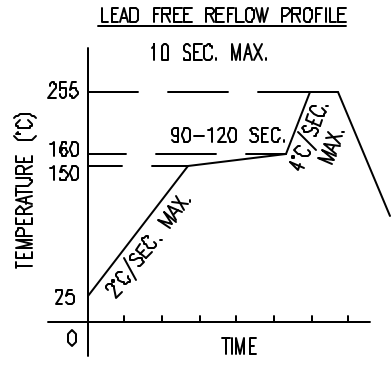
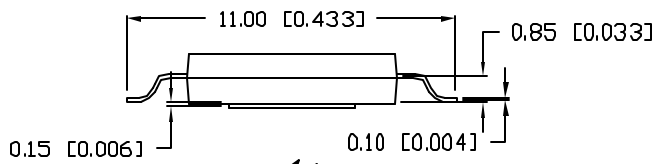
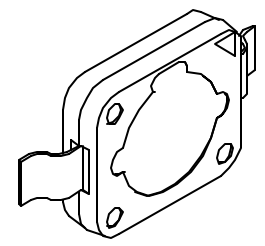
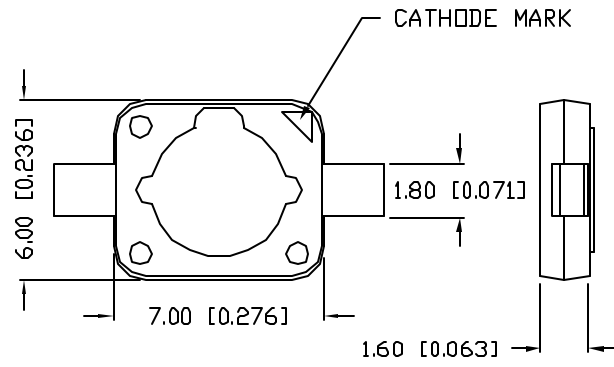

ELECTRO-OPTICAL CHARACTERISTICS TA=25°C

PARAMETER	SYMBOL	MIN	TYP	MAX	UNITS	TEST COND
PEAK WAVELENGTH			525		nm	
FORWARD VOLTAGE	V _f		3.2	4.0	V	I _f =350mA
REVERSE VOLTAGE	V _r	5			V	I _r =10μA
AXIAL INTENSITY	I _v	33		60	lm	I _f =350mA
VIEWING ANGLE			120		2x theta	
EMITTED COLOR:			GREEN			
EPOXY LENS FINISH:			CLEAR			

LIMITS OF SAFE OPERATION AT 25°C

PARAMETER	MAX	UNITS
PEAK FORWARD CURRENT*	500	mA
STEADY CURRENT	350	mA
POWER DISSIPATION	2.0	W
DERATE FROM 25°C	-1.2	mW/°C
OPERATING, STORAGE TEMP.	-40 TO +85	°C

*T<10μS

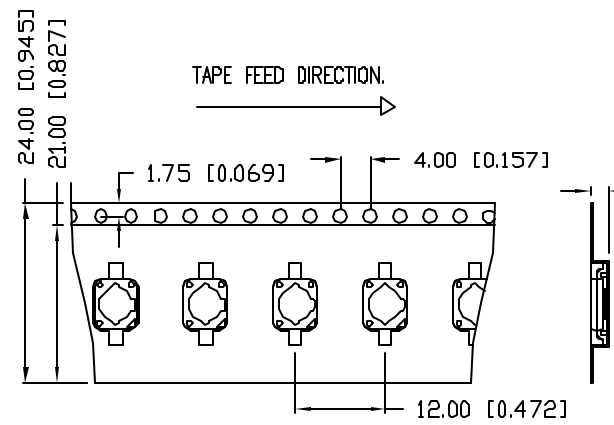
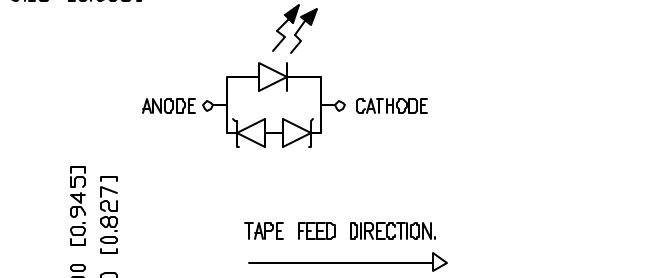

TOTAL TIME ABOVE 220°C IS 60 SECONDS MAX.

NOTE:

250 PECES PER REEL

CAUTION: STATIC SENSITIVE DEVICE
FOLLOW PROPER E.S.D. HANDLING PROCEDURES
WHEN WORKING WITH THIS PART.

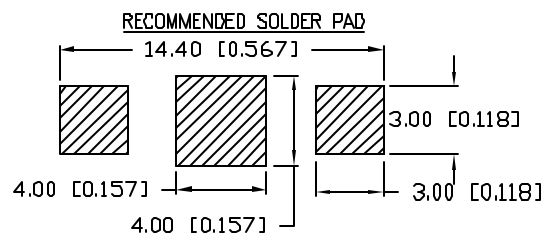

UNCONTROLLED DOCUMENT

*UNLESS OTHERWISE SPECIFIED TOLERANCES PER DECIMAL PRECISION ARE: X=±1 (±0.039), XX=±0.5 (±0.020), XXX=±0.25 (±0.010), XXXX=±0.127 (±0.005), LEAD SIZE=±0.05 (±0.002), LEAD LENGTH=±0.75 (±0.030), MIN.=+DECIMAL PRECISION -0.00, MAX.=+0.00 -DECIMAL PRECISION

REV.	PART NUMBER
A	SML-LX2723UPGC-TR

7mm X 6mm SURFACE MOUNT HIGH POWER LED,
525nm ULTRA PURE GREEN , TAPE AND REEL.

CONFIDENTIAL INFORMATION
THE INFORMATION CONTAINED IN THIS DOCUMENT IS THE PROPERTY OF LUMEX INC. EXCEPT AS SPECIFICALLY AUTHORIZED IN WRITING BY LUMEX INC., THE HOLDER OF THIS DOCUMENT SHALL KEEP ALL INFORMATION CONTAINED HEREIN CONFIDENTIAL AND SHALL PROTECT SAME IN WHOLE OR IN PART FROM DISCLOSURE AND DISSEMINATION TO ALL THIRD PARTIES.

RELIABILITY NOTE
OUR MANY YEARS OF EXPERIENCE DATA ACCUMULATION INDICATE THAT SOLDER HEAT IS A MAJOR CAUSE OF EARLY AND FUTURE FAILURE. PLEASE PAY ATTENTION TO YOUR SOLDERING PROCESS.

290 E. HELEN ROAD
PALATINE, IL 60067-6976
PHONE: +1.847.359.2790
US WEB: www.lumex.com
TW WEB: www.lumex.com.tw

DRAWN BY:	CHECKED BY:	APPROVED BY:	DATE:
JN			9.04.07
			PAGE: 1 OF 1
			SCALE: N/A